

M12 MALE / M12 FEMALE 0° SHIELDED

PUR 4X2X0.25 shielded GRAY, 6m

Male straight – female straight

M12 – M12, 8-pole

shielded

Plastic housings with good resistance against chemicals and oils.

The resistance to aggressive media should be individually tested for your application. Further details on request.

Further cable lengths on request.

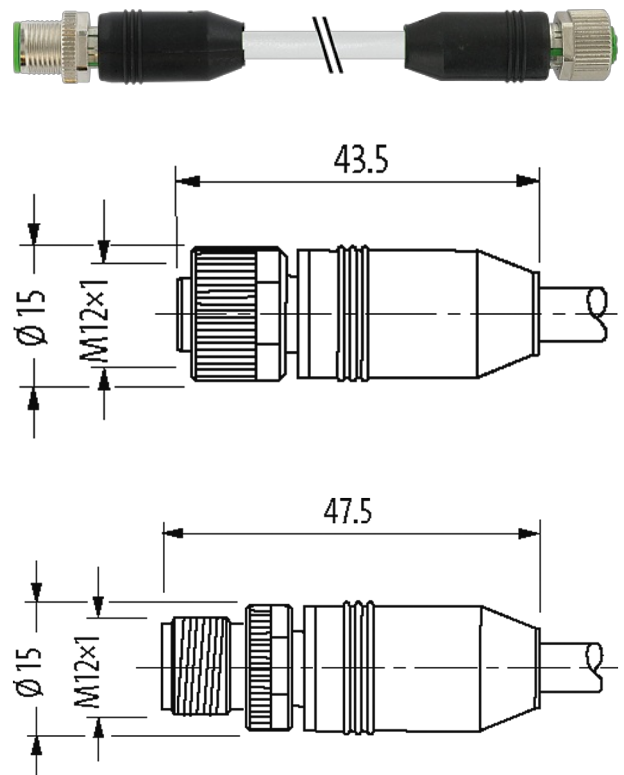
[Link to Product](#)**Illustration**

Product may differ from Image

Approvals

* only for products with UL/CSA approved cable

Form

Form 48041

Cables

Cable number	286
No./diameter of wires	4 × 2 × 0.25 mm ²
Wire isolation	PP (wh, br, gn, ye, gr, pk, bl, rd)
Jacket Color	gray
Material (jacket)	TPU

Outer Ø	7.1 mm ±5%
Bend radius (moving)	15× outer Ø
Temperature range (fixed)	-40...+90 °C
Temperature range (mobile)	-5...+90 °C
Cable identification	286
Approval (cable)	CE conform
Cable weight [g/m]	74,80
Material (wire)	Cu wire, bare
Resistor (core)	max. 79 Ω/km (20 °C)
Single wire Ø (core)	0.1 mm
Construction (core)	32× 0.1 mm (multi-strand wire class 6)
Diameter (core)	4× 2× 0.25 mm ²
AWG	similar to AWG 24
Material (wire isolation)	PP
Material property (wire isolation)	CFC-, halogen-, cadmium-, silicone- and lead-free
Shore hardness (wire isolation)	65 ±5 D
Wire-Ø incl. isolation	1.2 mm ±5%
Color/numbering of wires	br, wh, rd, bl, pk, gr, ye, gn
Shield	yes
Material (jacket)	TPU
Shore hardness (jacket)	85 ±5 A
Outer-Ø (jacket)	7.1 mm ±5%
Color (jacket)	gray
chemical resistance	good resistance to oil, gasoline and chemicals (EN 60811-404)
thermal resistance	flame retardant EN 60332-1
Nominal voltage	300 V AC
Test voltage	1500 V AC
Current load capacity	to DIN VDE 0298-4
Temperature range (fixed)	-40...+90 °C
Temperature range (mobile)	-5...+90 °C
Bend radius (fixed)	7.5× outer Ø
Bend radius (moving)	15× outer Ø

Technical Data

Operating voltage	max. 30 V AC/DC
Rated surge voltage	0.8 kV
Operating current per contact	max. 2 A
Locking of ports	Screw thread (M12×1 mm) recommended torque 0.6 Nm, self-securing
Protection	IP65, IP66K, IP67 inserted and tightened (EN 60529)

Commercial data

country of origin	DE
customs tariff number	85444290
EAN	4048879139427
eClass	27279218
Packaging unit	1

Sketch

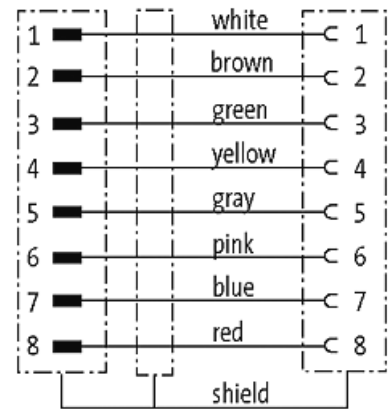

Male

Female

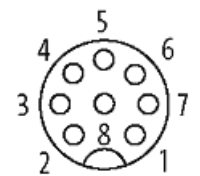
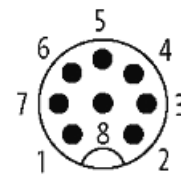

Product may differ from Image